

FOUR SEASONS™

# FS200 MANUAL



**Read and save these instructions**

## **INSTRUCTIONS FOR USE**

## TABLE OF CONTENTS

<b>Technical data</b>	<b>19</b>
<b>Product features</b>	<b>20</b>
<b>Product overview</b>	<b>21</b>
<b>Assembly and use</b>	<b>22</b>
Preparing for operation	22
Reset heater	22
<b>Using the Four Seasons™</b>	<b>23</b>
<b>Replacing the filter</b>	<b>24</b>
Replacement filter – FS200F	24
<b>Cleaning and maintenance</b>	<b>25</b>
Cleaning the humidifier wick frame	25
<b>Cleaning the water tank</b>	<b>26</b>
Storage	26
<b>Trouble shooting</b>	<b>27</b>

## TECHNICAL DATA

---

### Technical data\*

---

Type designation	FS200
Power consumption	2000W
Power supply voltage	220–240V ~ 50Hz
Capacity of Humidification	347 g/h
Volume of air flow	136 m <sup>3</sup> /h at high setting
Dimensions	230 x 260 x 650 mm
Weight	5.2 kg

---

\* Subject to change

## WELCOME

Congratulations on your purchase of the Four Seasons™ combination “heater” / “humidifier” / “air purifier” / “fan”! This amazing product combines all the benefits and comforts of a space heater, a humidifier, an air purifier and fan into one space-saving and money-saving product. You’ll soon agree that the Four Seasons™ is one product you can’t live without!

Please be sure to read the following instructions carefully to ensure optimal performance and safety.

**[envion.com](http://envion.com)**

## PRODUCT FEATURES

- Durable, washable cloth wick
- LED low water level indicator light
- 3 independent controls settings (Heater, Humidifier + Fan, Heater + Humidifier)
- 3 fan speed settings and 3 heating power levels (LOW / MEDIUM / HIGH)
- Self-regulating PTC heater and over-heat protection
- Evaporative humidification eliminates the issue of “white powder”
- Tip-over sensor for smart automatic shutoff control for the whole unit
- Empty water sensor for smart automatic power shutoff for the humidifier
- Filter effectively removes, smoke, pollen, dust, animal dander, dust mites from the air



## PRODUCT OVERVIEW

1. Control panel
2. Humidifier water sensor
3. Humidifier wick frame
4. Wick frame release tab
5. Water tank
6. Cover frame
7. Humidifier wick
8. Air outlet grill
9. Fan speed switch
10. Refill light
11. Heater + Humidifier
12. Humidifier + Fan
13. Heater only
14. Function knob
15. Power button
16. Heater knob
17. Filter

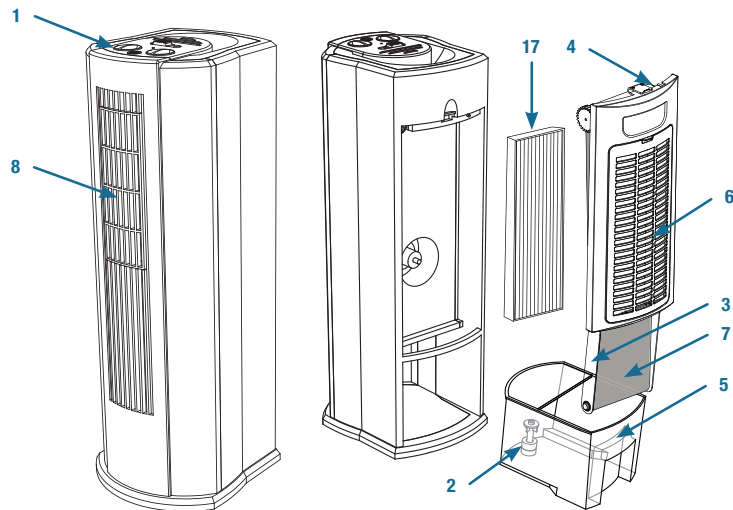

## CONTROL PANEL

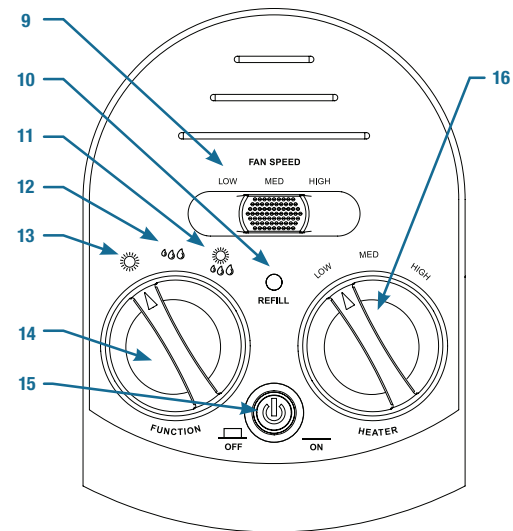

## ASSEMBLY AND USE

### PREPARING FOR OPERATION

 Unplug the Four Seasons™ unit prior to filling the tank with water.

1. Open the packing box and take out the Four Seasons™ unit.
2. Turn the unit upright for operation.
3. To remove the humidifier wick frame, press the release tab and pivot the frame outwards and then lift it out of the unit. See Figure 1.

 You must remove the wick frame before you can remove the tank.

4. Remove the tank by sliding it out of the unit (see Figure 2).
5. Fill the water tank with clean water to maximum water level marking on tank.

 Do not overfill the tank. Use extreme caution to ensure that water is poured only into the water tank and that the rest of the unit stays dry. Never plug in the unit if it gets wet.

6. After filling, put the tank back into the main body and replace the humidifier wick frame.

### RESET HEATER

 This heater is equipped with a temperature limiting thermostat. If the unit should sense an overheat condition, the element will stop heating. It can only resume operation when user manual reset the unit.

Unplug the unit and wait 10 minutes for the unit to cool down, then plug unit back and follow the “Using the Four Seasons™” instruction described in this manual.

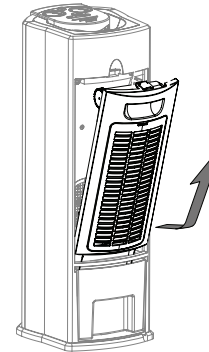

FIGURE 1

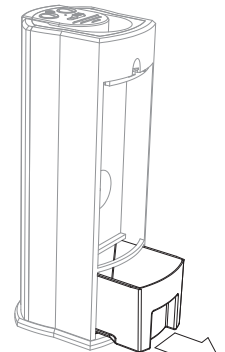
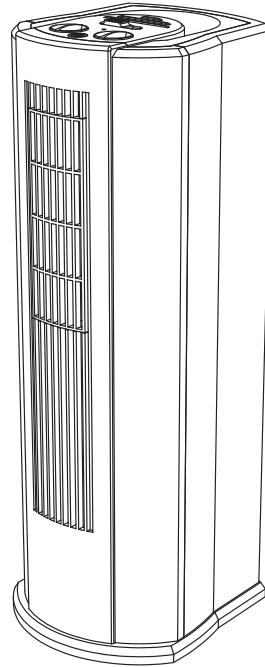

FIGURE 2

## USING THE FOUR SEASONS™

1. Plug the unit into an electrical outlet and press the power button to turn on your Four Seasons™ unit.
  2. Turn the mode knob to select the desired function. You may choose to use either the heater, the humidifier, or the heater and humidifier together.
- i** No matter which mode you select, the air purifier feature will always be active.
3. Once you have chosen the mode you can control how much air passes through your Four Seasons™ unit by sliding the fan speed button to low, medium or high as you prefer.
  4. When you select either the heater mode or the heater + humidifier mode you may control the amount of heat your Four Seasons™ produces. Choose low, medium or high heat output.





## REPLACING THE FILTER

### REPLACEMENT FILTER – FS200F

1. Make sure the unit is turned off and unplugged. To remove the cover frame, press the release tab and pull the frame outwards (see Figure 3A/B).
2. Remove the filter by pulling the filter out from the unit (see Figure 4).
3. Insert a new filter, then place cover frame back into position.

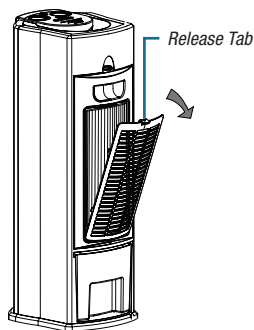

FIGURE 3A

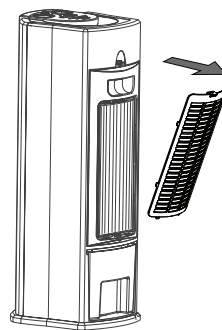

FIGURE 3B

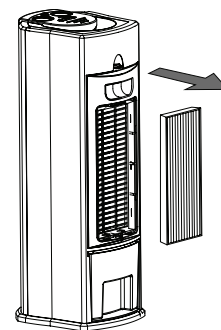

FIGURE 4

## CLEANING AND MAINTENANCE

### CLEANING THE HUMIDIFIER WICK FRAME

 Always unplug the Four Seasons™ unit prior to cleaning or other maintenance.

1. Remove the humidifier wick frame as explained in the “Assembly and use” section of this manual.
2. With the humidifier wick frame lying in front of you, gently bend each side of the wick frame to release the bottom roller (see Figure 5).
3. Release the top roller from the frame by carefully bending back the frame bracket and removing the roller axle from the bracket hole (see Figure 6). Remove wick from rollers.
4. To clean the wick you may wash it in your washing machine on a gentle cycle or use a mild detergent to wash by hand. Rinse with clean water. Be sure it is completely dry before reinserting.
5. Reinsert the humidifier wick into the rollers and then insert the humidifier wick frame into the unit.

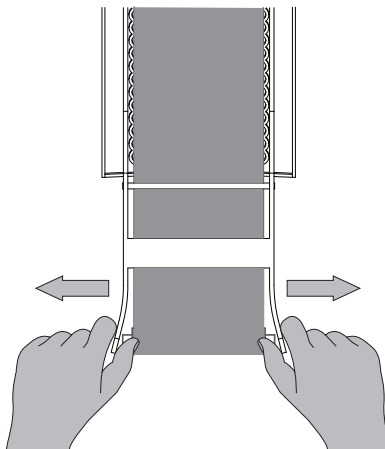

FIGURE 5

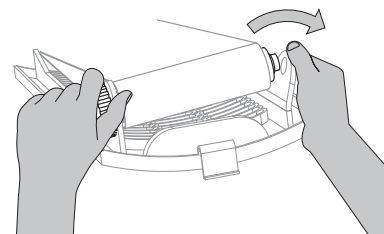



FIGURE 6

## CLEANING THE WATER TANK

1. Remove the humidifier wick frame as shown previously.
2. Remove the water tank as demonstrated earlier in this manual. Clean the tank with water and mild detergent.
3. Rinse thoroughly with clean water before reinstalling. Hand wash only.

### STORAGE

Loop the cord around 15–20 cm and wrap with a cord tie. Place the unit in the original box and store in a cool, dry place.

 Any servicing other than as described in this manual should be performed by an authorized service representative. Do not wash the tank in the dishwasher.

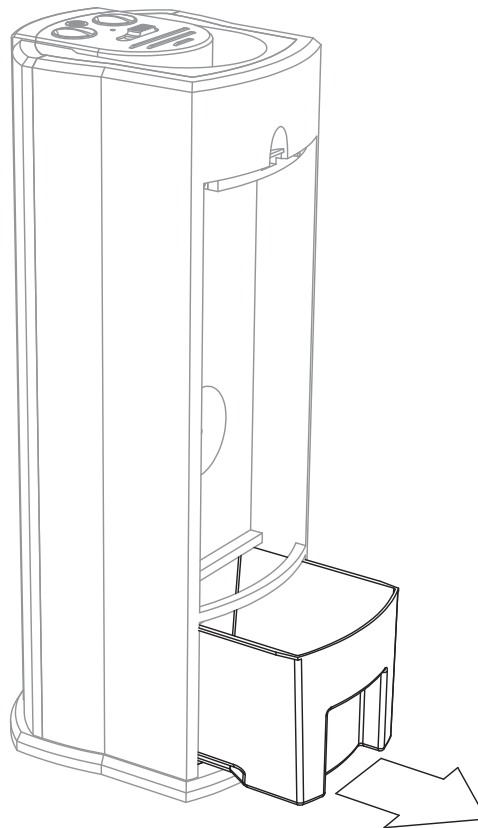

## TROUBLE SHOOTING

If you are having problems with your Four Seasons™, please refer to the following suggestions.

---

### **My Four Seasons™ unit will not operate**

---

Suggestions	Make sure the power button is pressed and in the down position.
	Make sure the unit is plugged into a functioning power outlet.
	Verify the wick frame and the inlet grill are properly installed.

---

### **My Four Seasons™ unit is not blowing as much air as it used to**

---

Suggestions	Verify that the fan speed is set correctly.
	Verify that nothing is blocking the air inlet grill or outlet grill.

---

### **My Four Seasons™ unit's humidifier feature isn't working**

---

Suggestions	Verify there is water in the tank.
	Verify the humidifier water sensor is floating in the water after filling tank.
	Make sure that the water tank is fully inserted.

---